

3/8" HOLES FOR WEIGHT

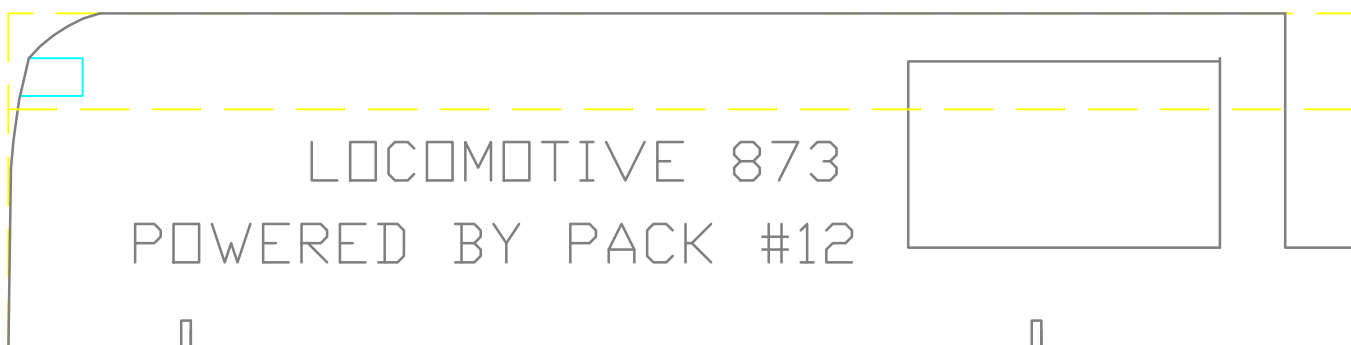

GLUE EXTRA WOOD TO BLOCK FOR REQUIRED HEIGHT

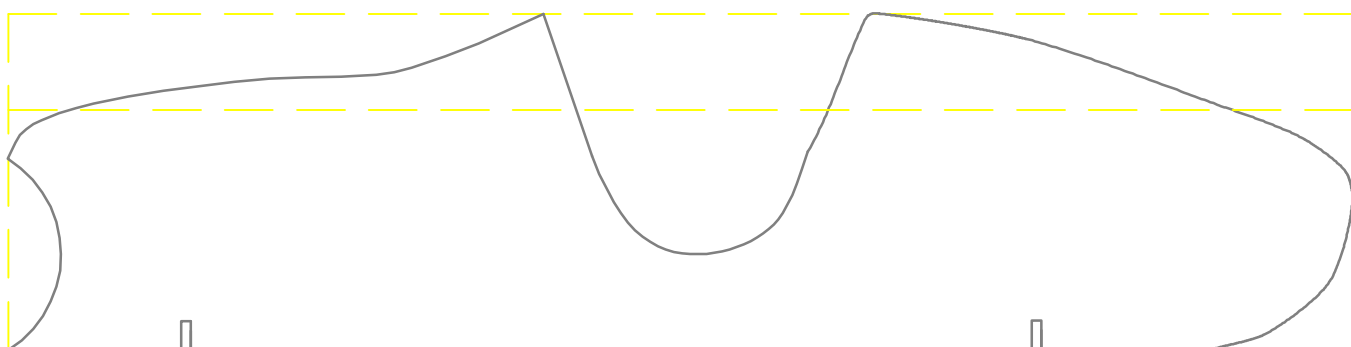

GLUE EXTRA WOOD TO BLOCK FOR REQUIRED HEIGHT

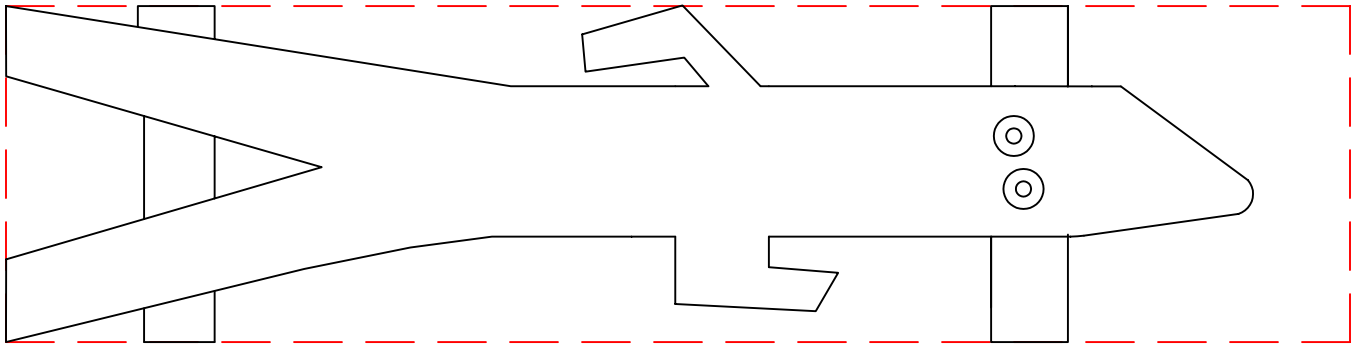

GUMBY

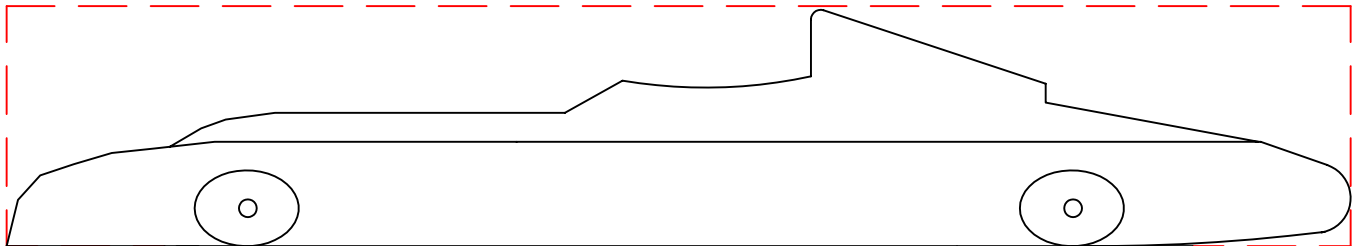
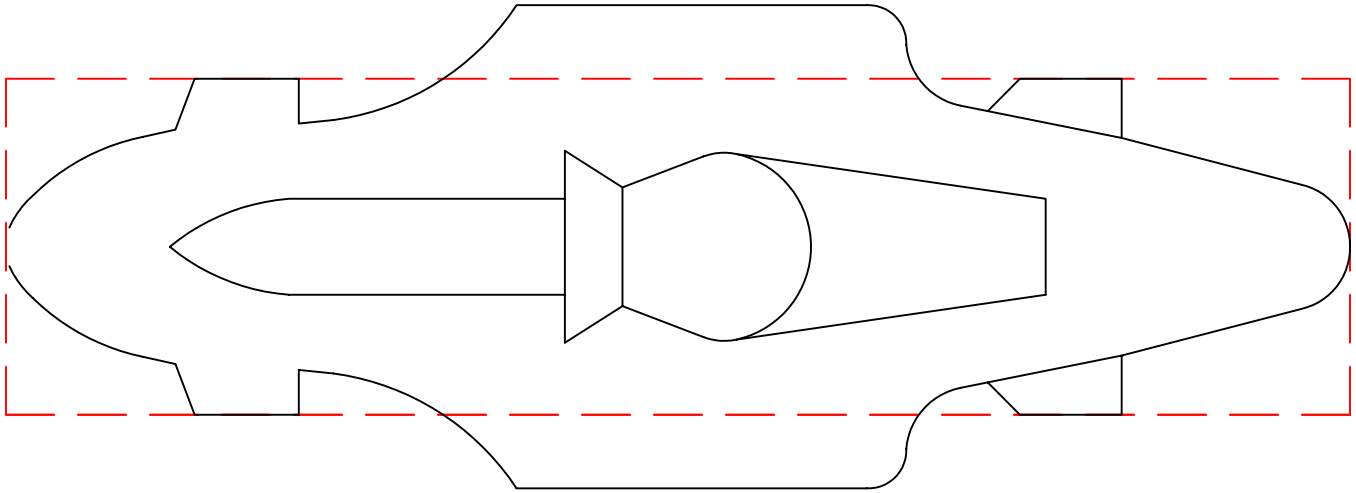
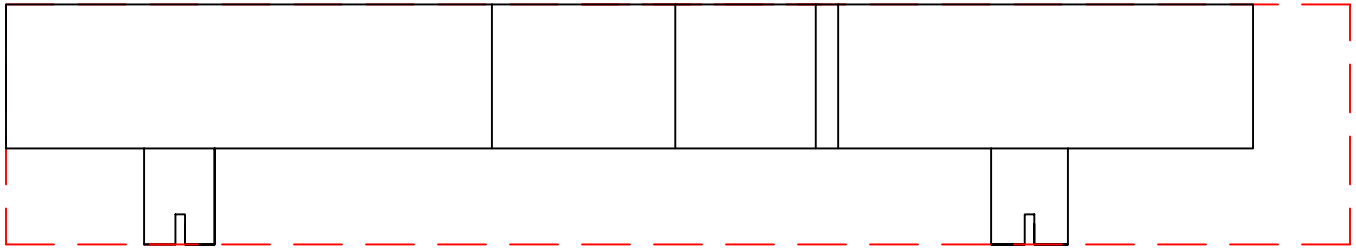

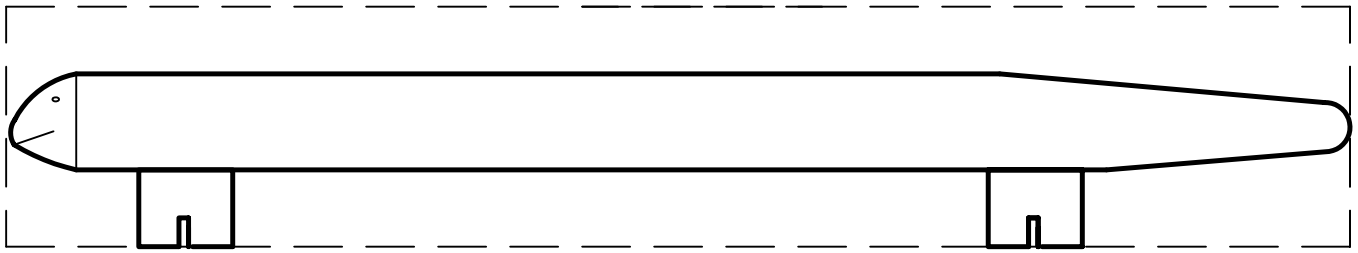

"SNEAKY SNAKE SIDE VIEW"

FRAGILE DESIGN, USE REINFORCEMENT

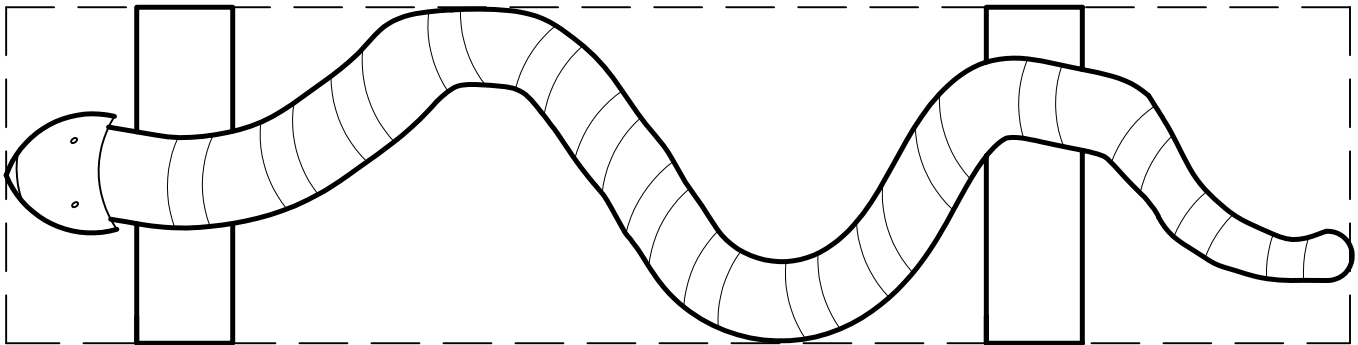

"SNEAKY SNAKE TOP VIEW"

1/8" WOOD DOWELS

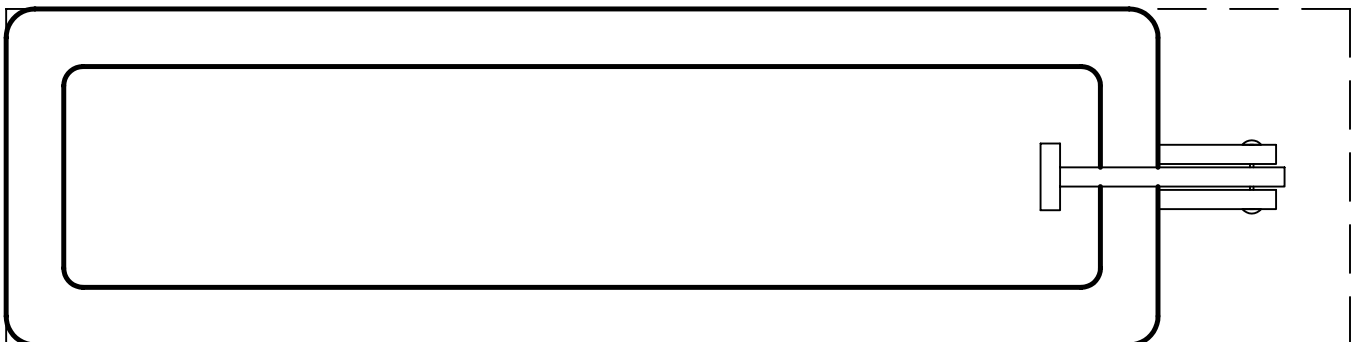

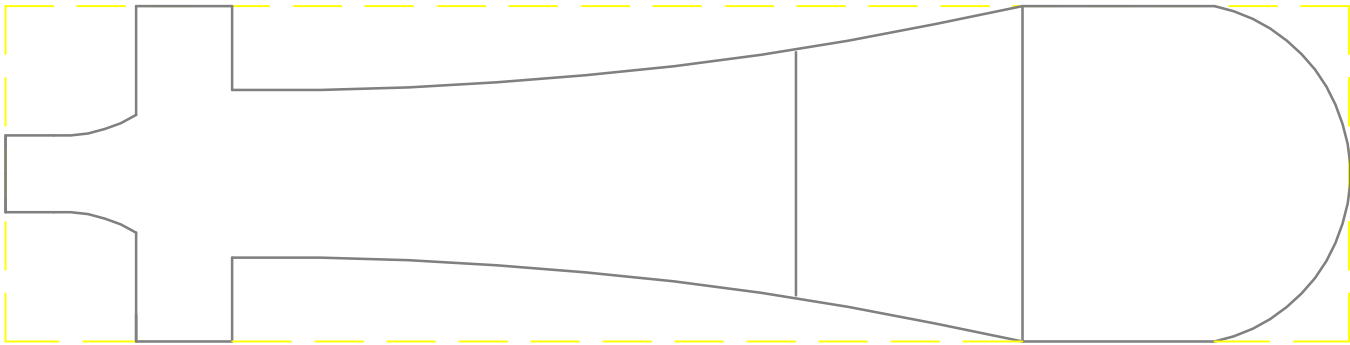
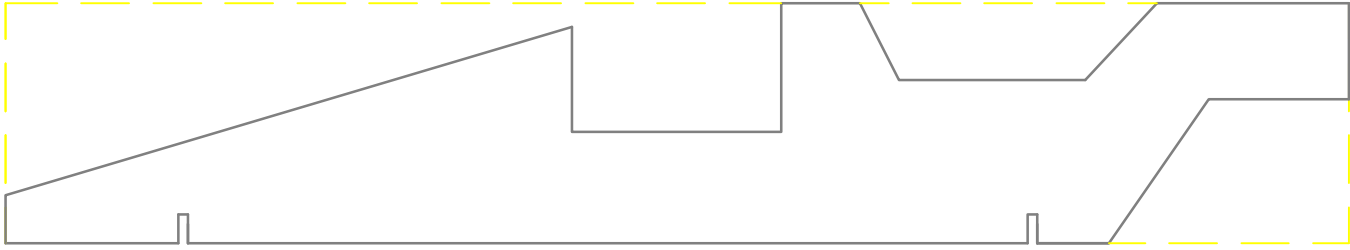

"DRAGSTER TOP VIEW"

"DRAGSTER"

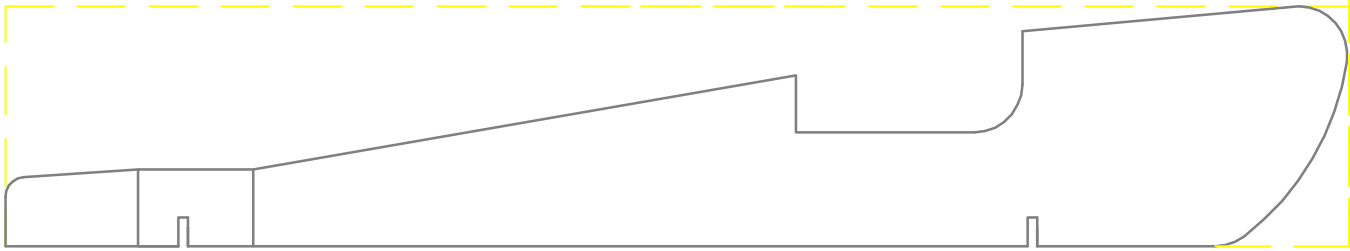

"SLOW SHORT STUFF"



ADD WEIGHT IN 3/8" HOLES

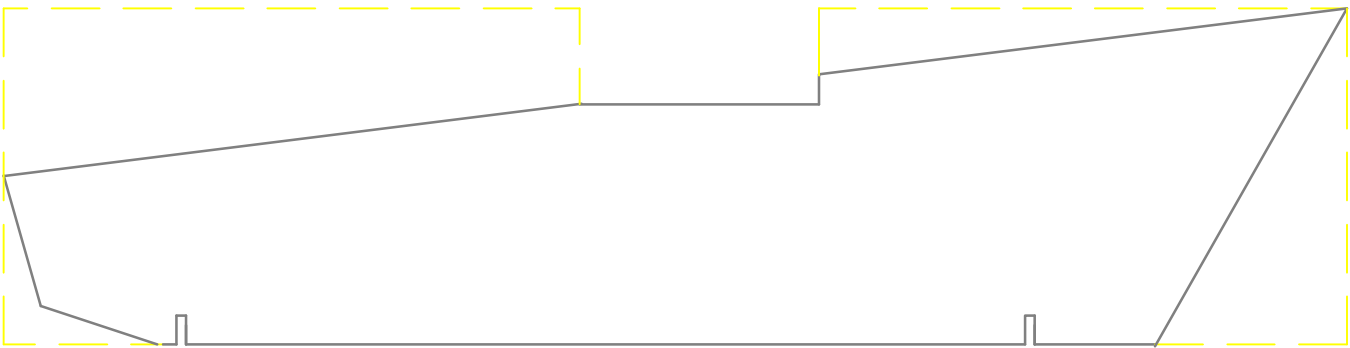
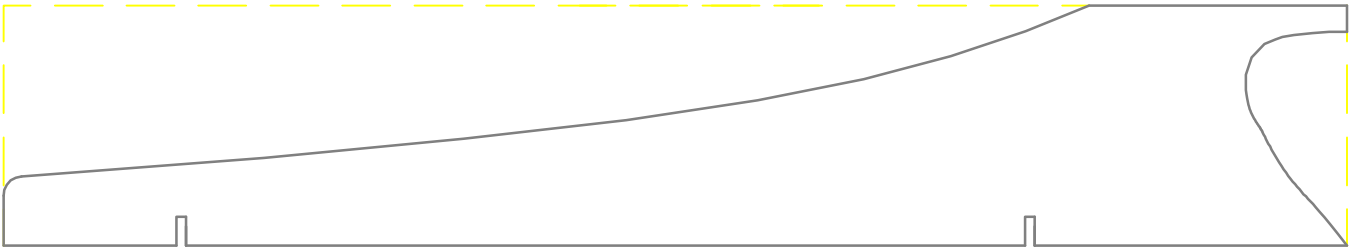
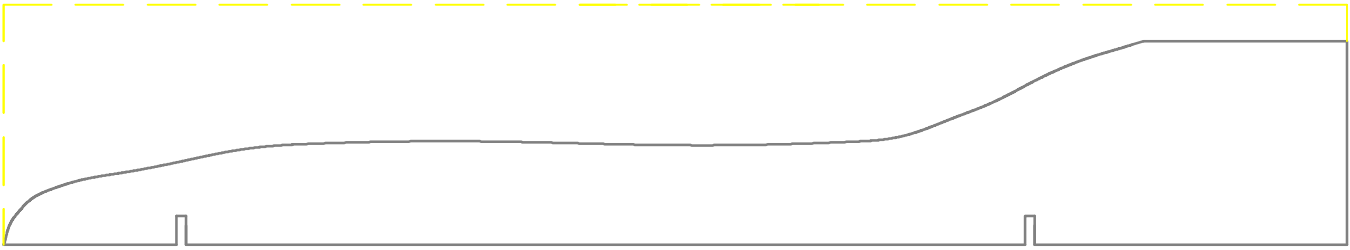

OLD STYLE BLOCK

MINIMOUSE – CUT PROFILE THEN SHAPE BODY

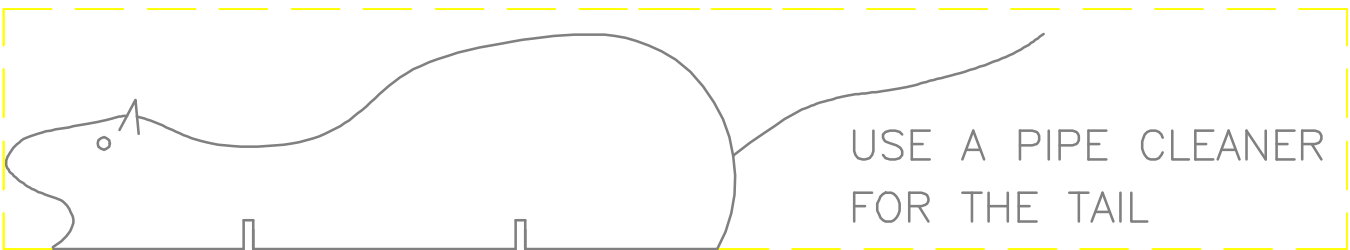

USE A PIPE CLEANER FOR THE TAIL

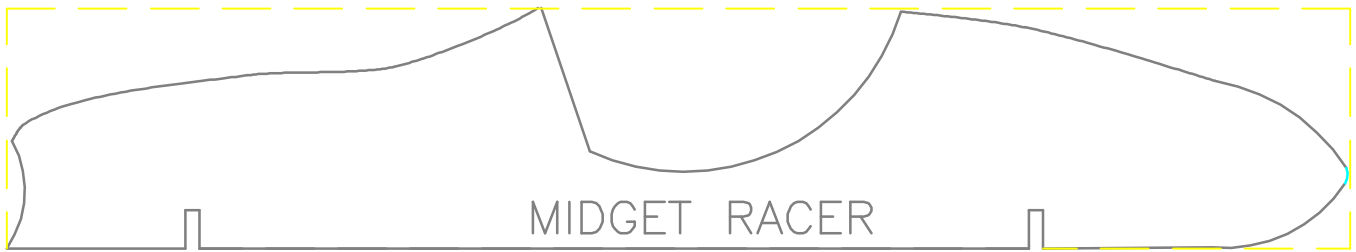
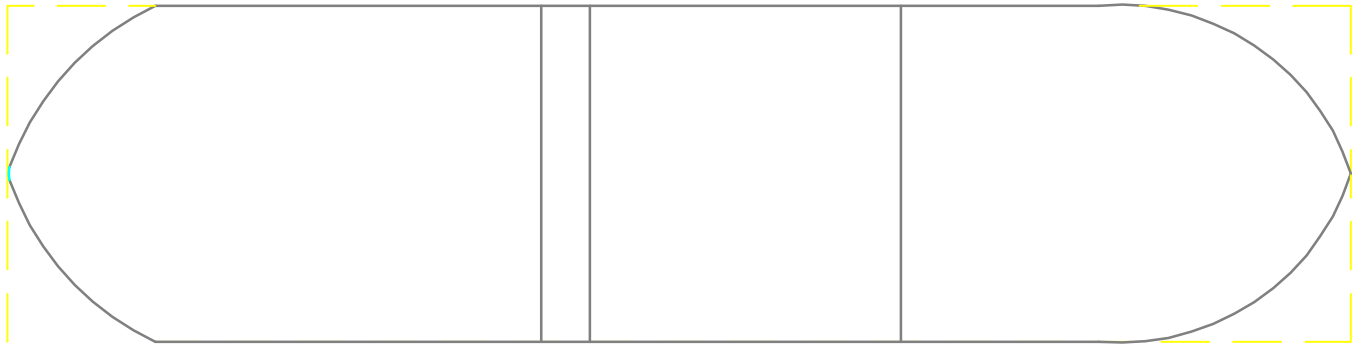

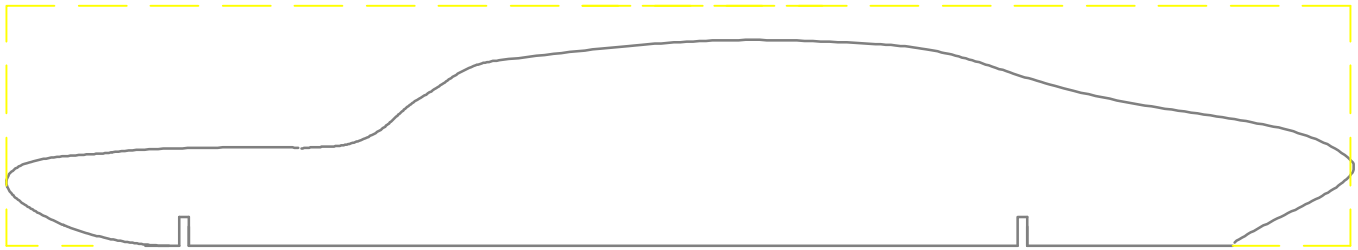
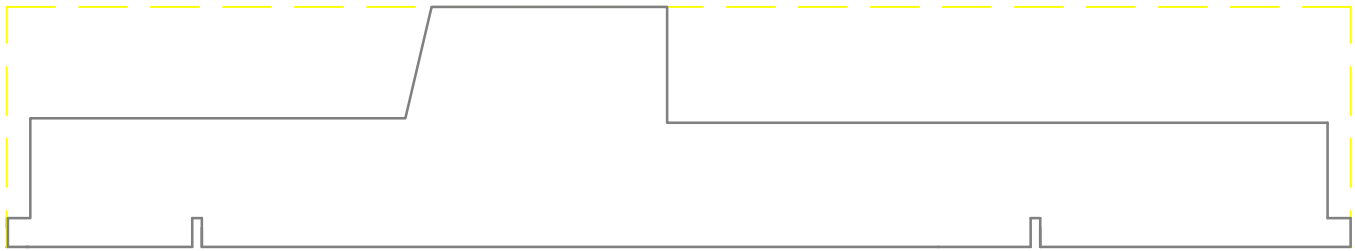
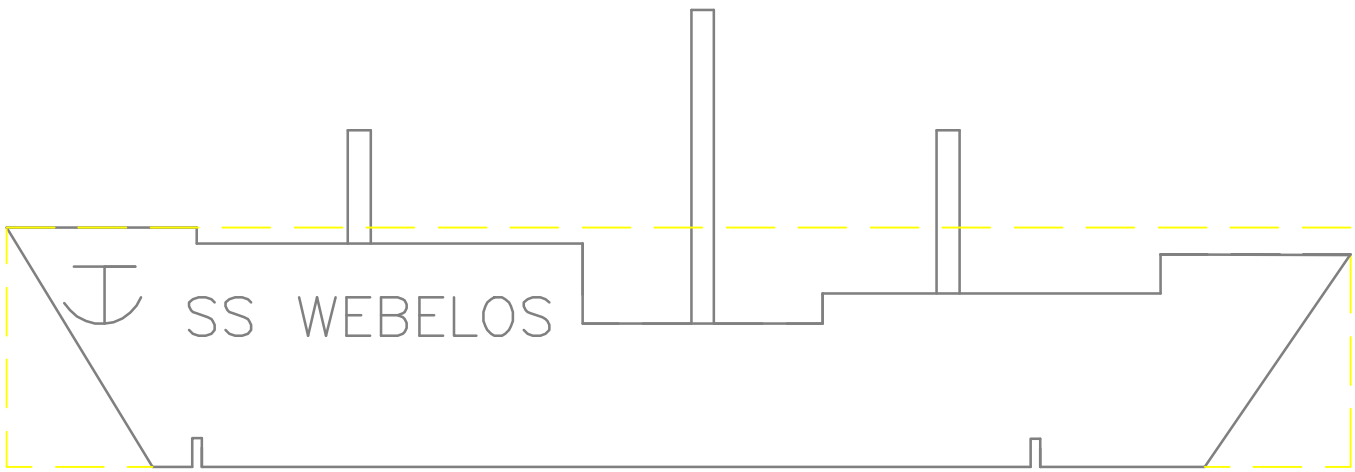
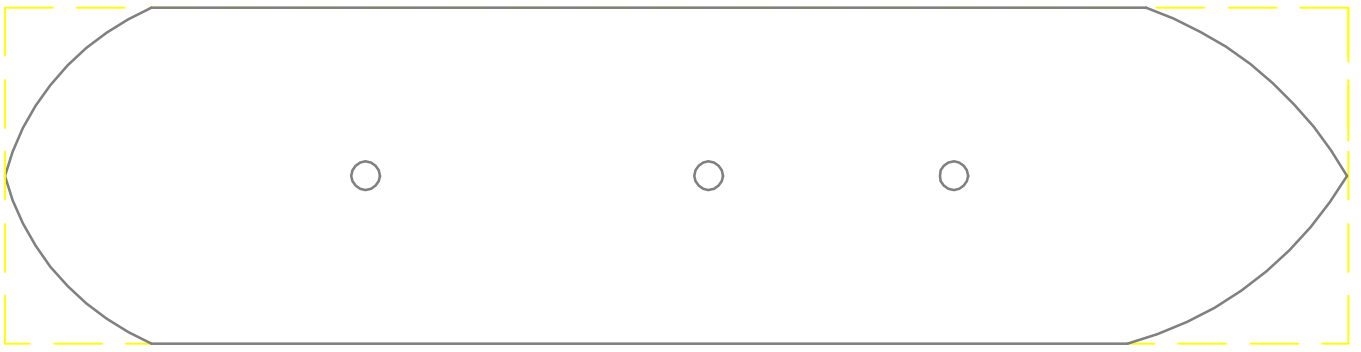

GLUE ON ROUNDED 1/2" DOWEL

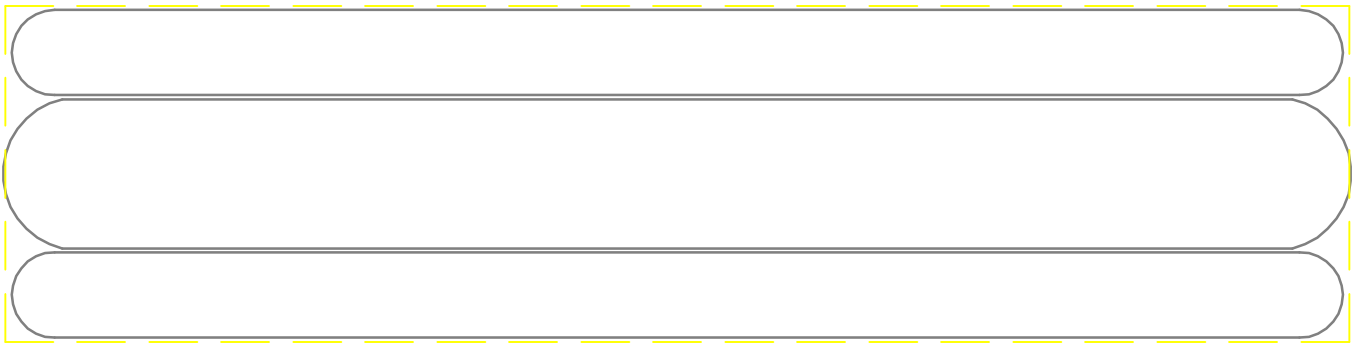
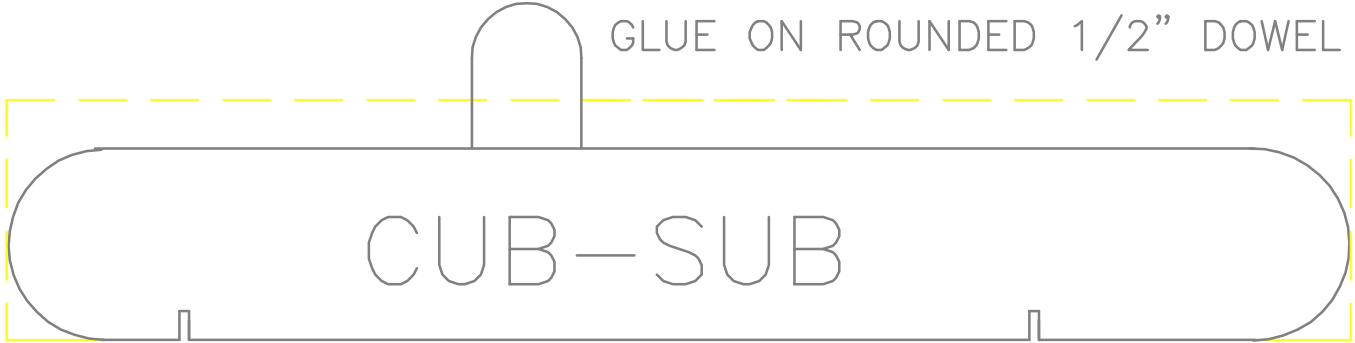

HOTDOGGER TOP VIEW

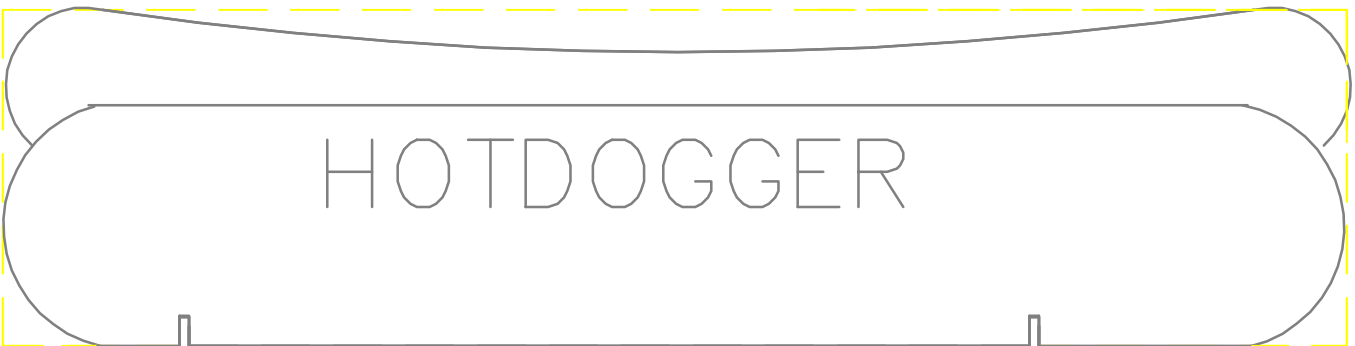

GLUE ADDITIONAL WOOD FOR HEIGHT

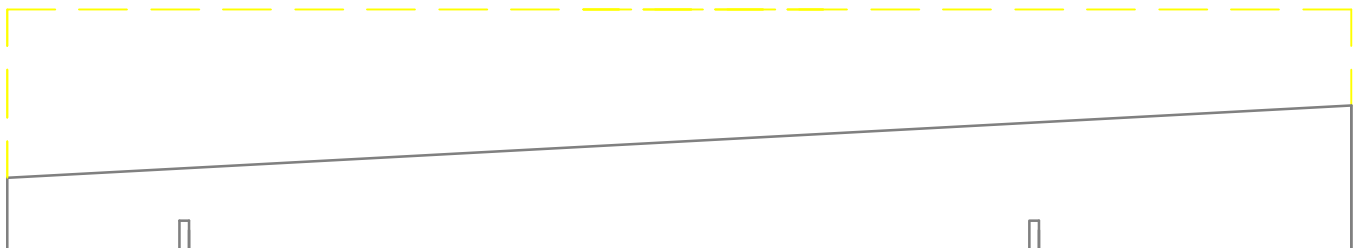



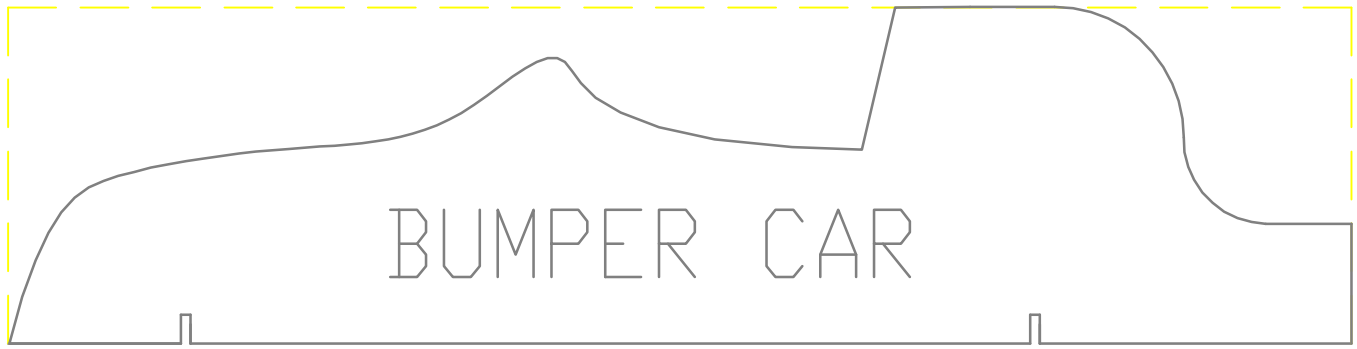

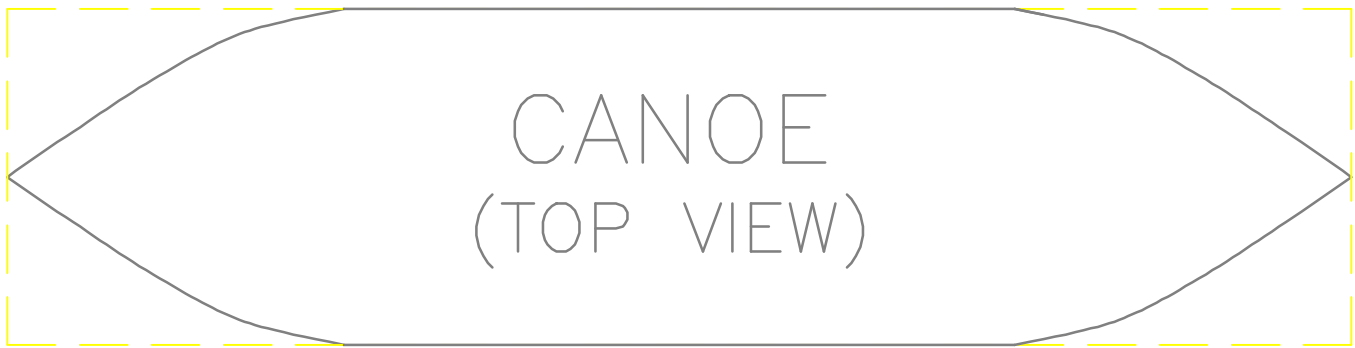
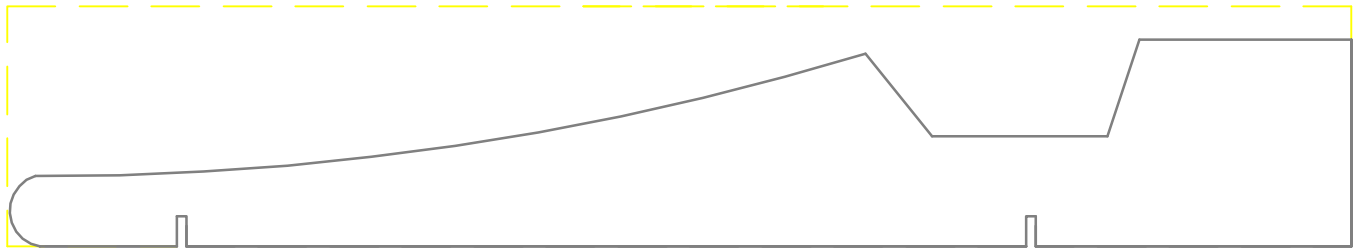
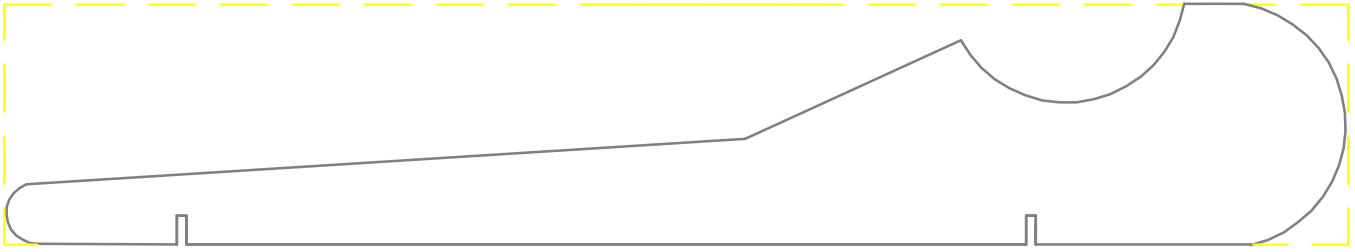

REQUIRES EXTRA HEIGHT

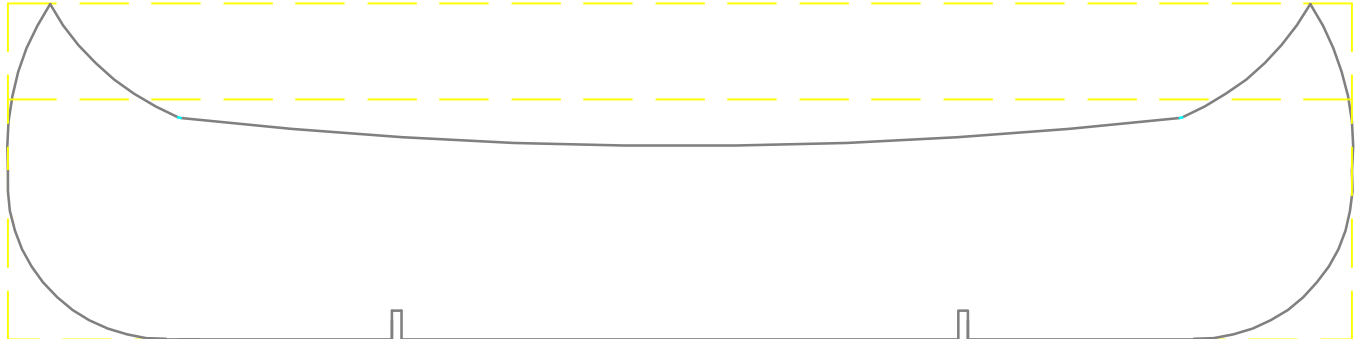

SHORTEN WHEELBASE

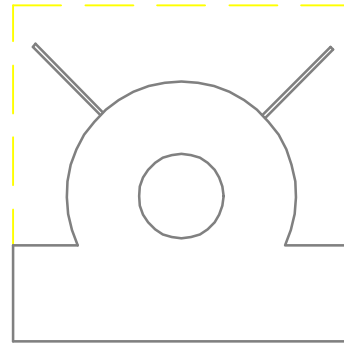
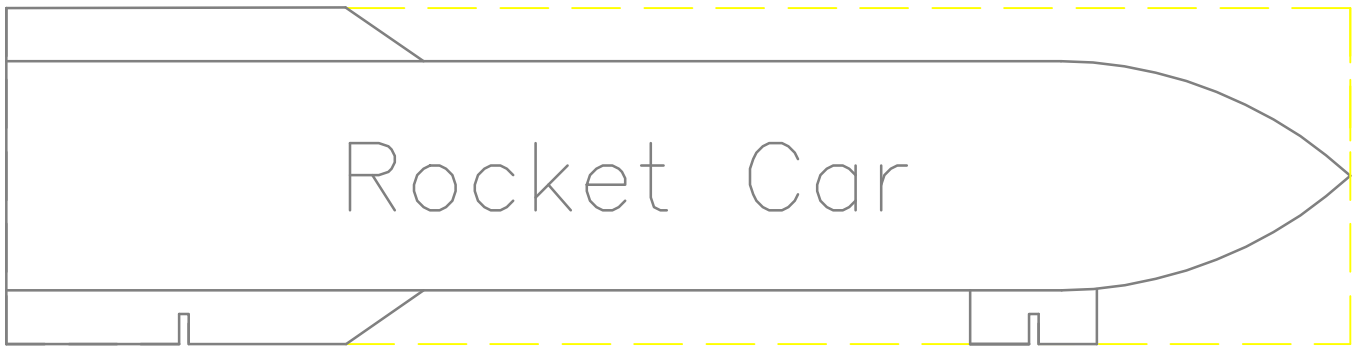

END VIEW

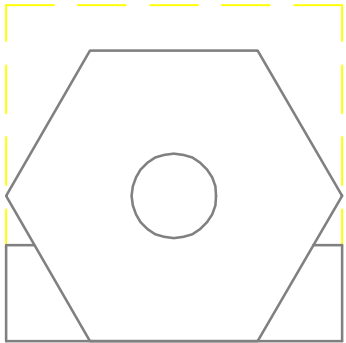

END VIEW

GLUE ADDITIONAL WOOD FOR THESE DESIGNS

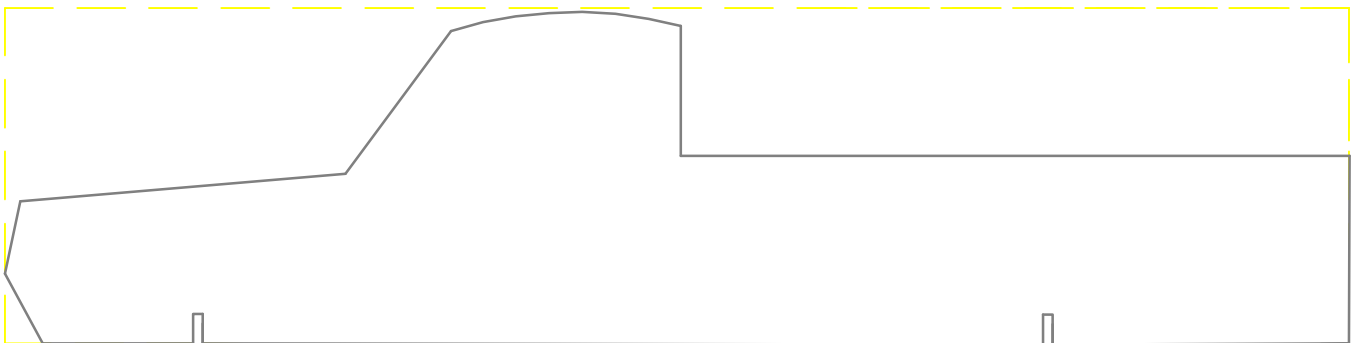
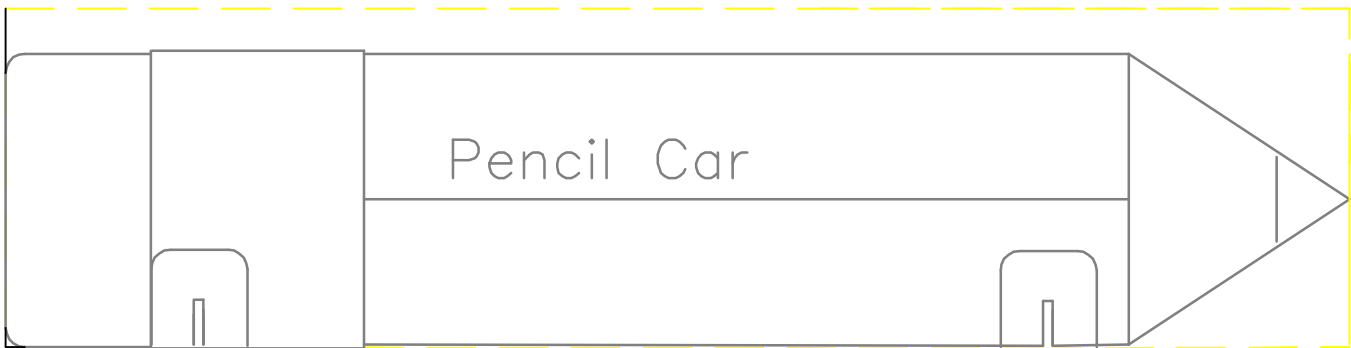

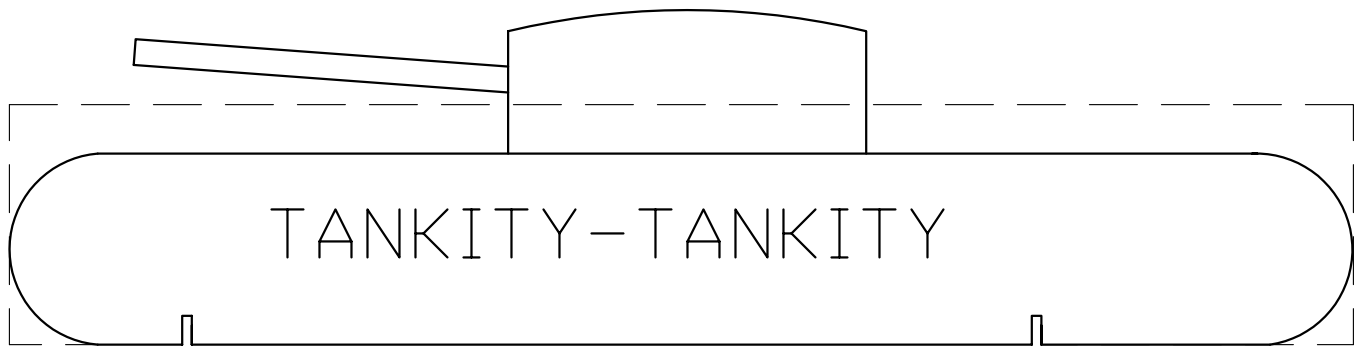

TANKITY-TANKITY

ADD WOOD FOR TURRET AND BARREL



ADD WEIGHT IN 3/8" HOLES

